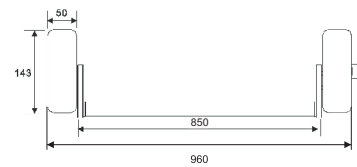
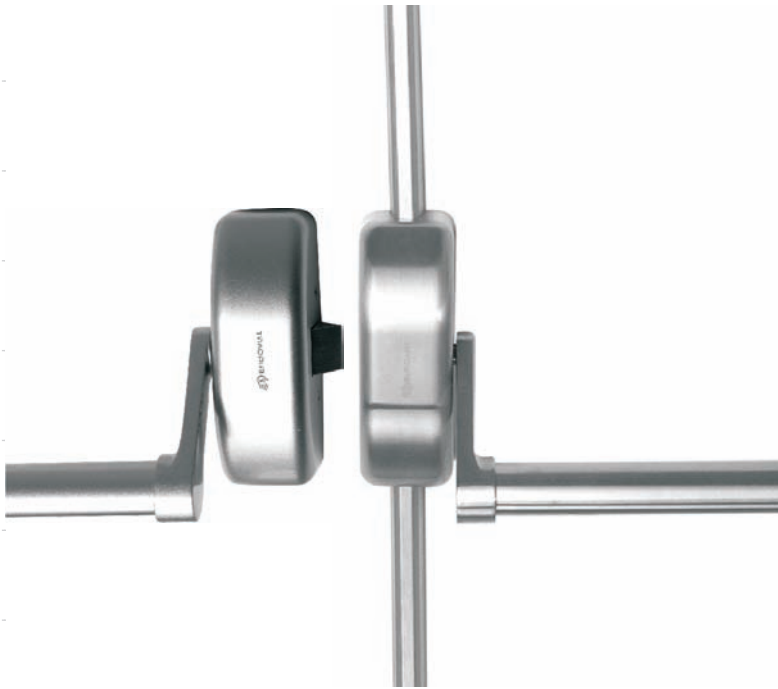
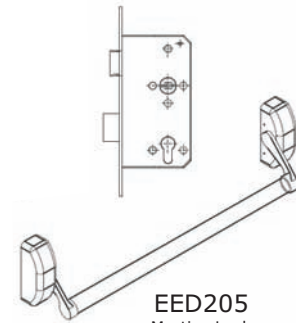
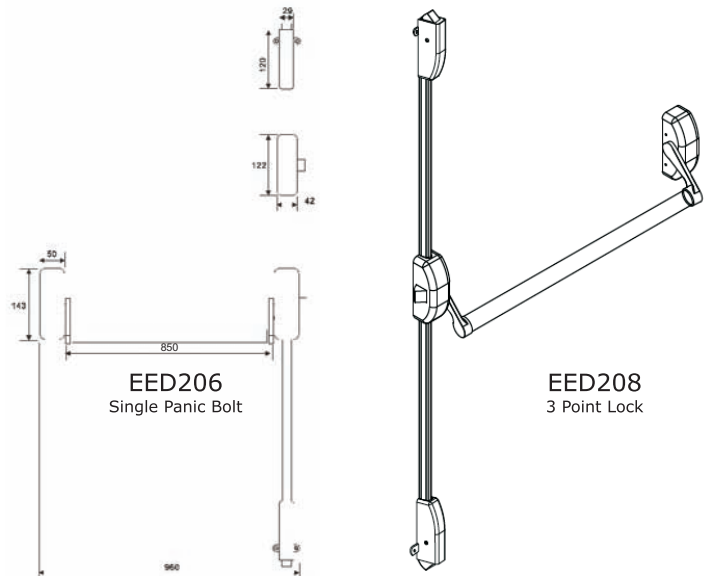
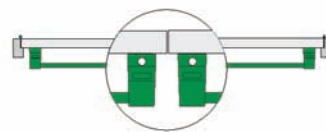
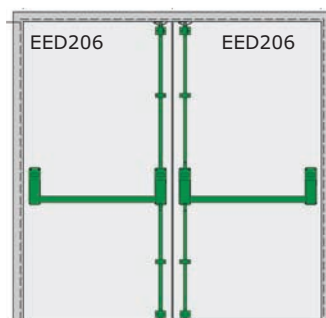
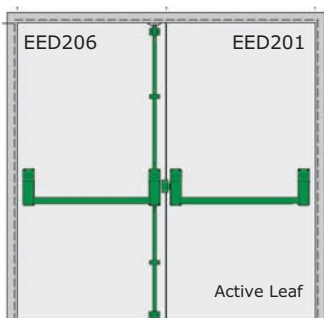

EED200 SERIES

EED201
Single Panic Latch

EED205
Mortice Lock

Finish: SSS
Double Door Configurations

Rebated Doors

Non Rebated Doors

EED206
Single Panic Bolt

EED208
3 Point Lock

Features

- Elegant and highly functional panic latch
- Operated by downward thrust of the cross bar to give a speedy exit in panic situation
- Available in painted steel and SS grade304
- Anti-thrust mechanism to protect against attack
- Fire rated for use on timber and steel doors

Product specification

- Suitable for doors upto 1440mm wide and 2200mm height
- Supplied with 850mm rod as standard
- Door weight upto 200kg
- Non handed, suitable with out alteration for left or right hand applications
- Top rods available for doors upto 3000mm high